

# Flexport<sup>®</sup> System Interface SenTec Digital Monitor

90442A-03

## Operations Manual

071-0971-00 Rev. A

**©2007 Spacelabs Medical, Inc.**

*All rights reserved. Contents of this publication may not be reproduced in any form without the written permission of Spacelabs Medical. Products of Spacelabs Medical are covered by U.S. and foreign patents and/or pending patents. Printed in U.S.A. Specifications and price change privileges are reserved.*

*Spacelabs Medical considers itself responsible for the effects on safety, reliability and performance of the equipment only if:*

- *assembly operations, re-adjustments, modifications or repairs are carried out by persons authorized by Spacelabs Medical, and*
- *the electrical installation of the relevant room complies with the requirements of the standard in force, and*
- *the equipment is used in accordance with the operations manual.*

*Spacelabs Medical will make available, on request, such circuit diagrams, component part lists, descriptions, calibration instructions or other information which will assist appropriately qualified technical personnel to repair those parts of the equipment which are classified by Spacelabs Medical as field repairable.*

*Spacelabs Medical is committed to providing comprehensive customer support beginning with your initial inquiry through purchase, training, and service for the life of your Spacelabs Medical equipment.*

**CORPORATE OFFICES**

**U.S.A.**

**Spacelabs Medical, Inc.**

5150 220th Ave SE

Issaquah, WA 98029

Telephone: 425-657-7200

Telephone: 800-522-7025

Fax: 425-657-7212

**Authorized EC Representative UNITED KINGDOM**

**Blease**

Beech House, Chiltern Court

Asheridge Road, Chesham

Buckinghamshire HP5 2PX

Telephone: 44 (0) 1494 784422

Fax: 44 (0) 1494 794414

*BirthNet, Clinical Browser, Data Shuttle, Flexport, Intesys, Mermaid, MOM, Multiview, PCIS, PCMS, PrintMaster, Quicknet, Sensorwatch, TRU-CAP, TRU-CUFF, TruLink, Ultralite, Ultraview, Ultraview Care Network, Ultraview Clinical Messenger, Ultraview Digital Telemetry, Ultraview SL, Uni-Pouch, UCW, Varitrend and WinDNA are trademarks of Spacelabs Medical, Inc.*

*Other brands and product names are trademarks of their respective owners.*

**Caution:**

**Rx Only** US Federal law restricts the devices documented herein to sale by, or on the order of, a physician.



**Before use, carefully read the instructions, including all warnings and cautions.**

---

# Table of Contents

---

Contents	Page
<b>Introduction</b>	
Overview . . . . .	1-1
Flexport System Interface Basics . . . . .	1-1
Setup . . . . .	1-2
Supporting Data Transfer . . . . .	1-3
Help Messages . . . . .	1-4
<b>SenTec Digital Monitor</b>	
Directory of Keys . . . . .	2-1
Overview . . . . .	2-3
Connecting the Flexport System Interface . . . . .	2-4
Display Detail . . . . .	2-4
Enabling Alarms . . . . .	2-6
Viewing Alarm Settings . . . . .	2-7
Entering Setup Information . . . . .	2-8
Freezing the Waveform on the Display . . . . .	2-10
Printing the Current Display . . . . .	2-10
Status Messages . . . . .	2-10
<b>Appendix A — Symbols</b>	



---

# Introduction

---

---

## Contents

Overview . . . . .	1
Flexport System Interface Basics . . . . .	1
Setup . . . . .	2
Supporting Data Transfer . . . . .	3
Help Messages . . . . .	4

---

---

## Overview

The Flexport<sup>®</sup> system interface provides access to monitoring data at the patient bedside. It enables data from compatible third-part peripheral devices such as ventilators, multigas analyzers, pulse oximeters, NIBP monitors, IV pumps, incubators, and capnographs to be displayed on Spacelabs Medical monitors.

The Flexport system interface provides current numeric data, alarm information, and selected waveforms to the Spacelabs Medical monitor, enables you to print the current display, and can support data transfer via the Data Shuttle<sup>®</sup> option (refer to *Supporting Data Transfer* on page 1-3).

Once device data is in the Spacelabs Medical monitor, it becomes an integral part of the monitoring system and can be communicated over the network to other locations providing alarms, centralized display, trending, and documentation capabilities at remote locations.

---

---

## Flexport System Interface Basics

The interface uses RS-232 serial communications to collect data and then transmits the data, via synchronous data link control (SDLC) communications, to the Spacelabs Medical monitor.

The Flexport system interface has a male, 9-pin, SDLC connector at one end and either a female, 6-pin, modular jack or a female, 8-pin receptacle at the other end (refer to *Figure 1-1*). The interface contains no operator controls. Power to the interface is provided by the Spacelabs Medical monitor through the SDLC connection.

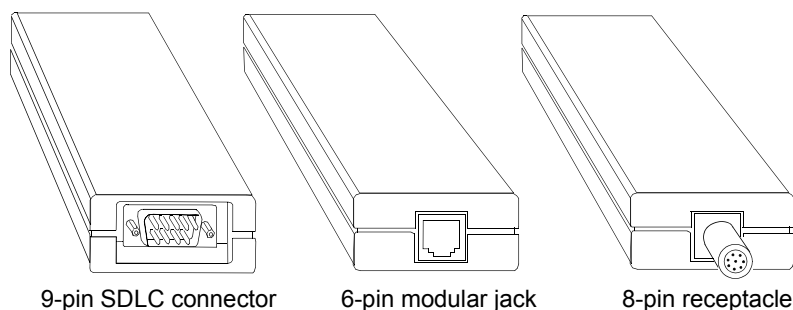
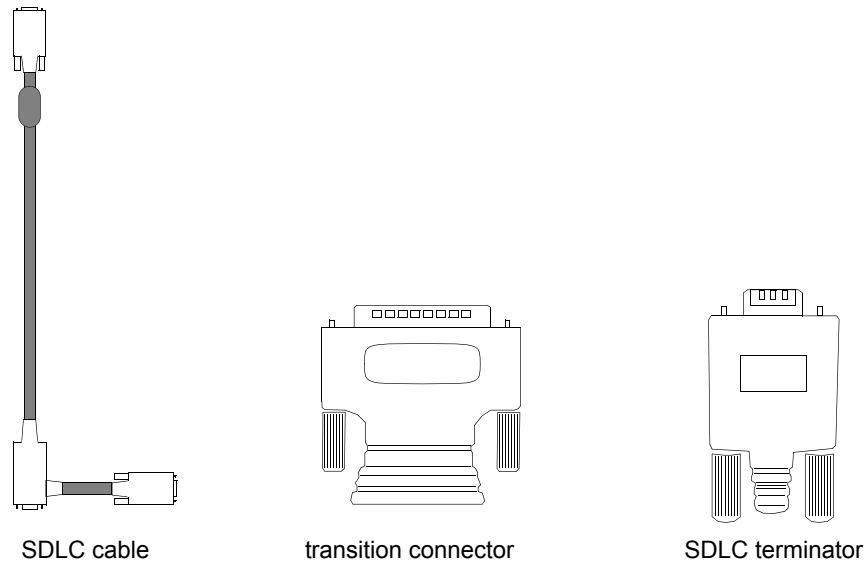

*Figure 1-1: Flexport system interface*

# Setup

The Flexport system interface uses two cables:

- The “L-shaped” SDLC cable connects the Spacelabs Medical monitor to the Flexport system interface.
- The modular cable has modular connectors (similar to U.S. telephone connectors) at each end and connects the Flexport system interface to the peripheral device.



*Figure 1-2: Flexport system interface connectors*

The transition connector adapts the modular cable to the peripheral device.

The SDLC terminator is used at one end of the SDLC cable when the SDLC cable is not used to connect additional Spacelabs Medical products to the Spacelabs Medical monitor.

**Note:**

- *After receiving your Flexport installation kit, contact your Field Service Engineer or your Biomedical Department to install your SDLC cable and terminator on your monitor or module housing.*
- *Additional installation details are available in the 90485/86/91/99 Module Housings and Power Supplies Service Manual (P/N 070-0680-xx, located on CD-ROM 084-0700-xx).*

## Connecting the Flexport System Interface

The Flexport system interface connects to a peripheral device such as a ventilator, IV pump, multigas analyzer, or capnograph as shown in *Figure 1-3*.

**Note:**

*Your device setup may differ from the graphic shown here. Refer to the chapter corresponding to your peripheral device for specific setup information.*

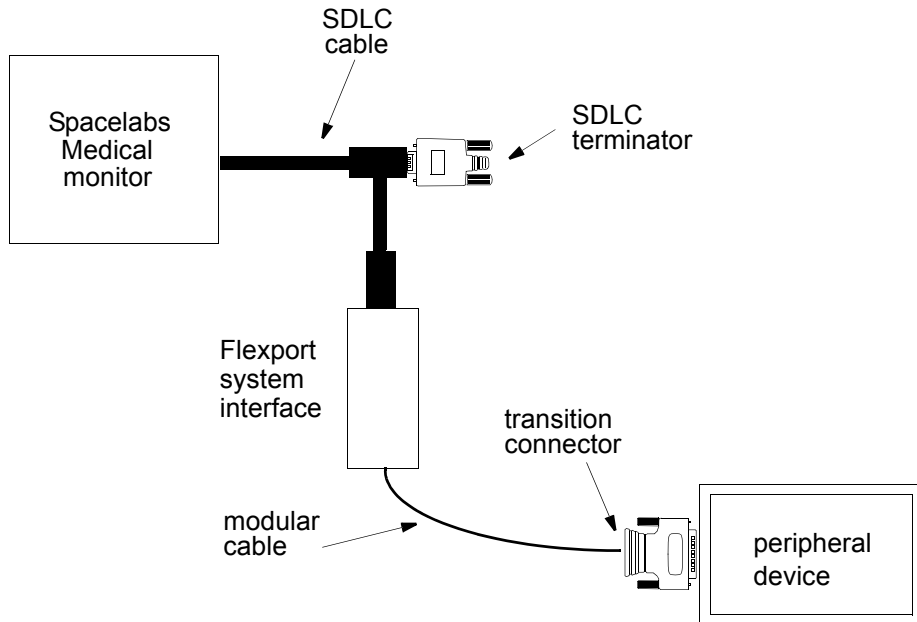

*Figure 1-3: Flexport system interface connections*

**Caution:**

**Attach only Spacelabs Medical-approved accessories to RS-232 connectors.**

---

## Supporting Data Transfer

If you use the interface with a Spacelabs Medical monitor that includes a multi-parameter module with the Data Shuttle option, you can use that module's data transfer capability to pass data from one monitor to another. To ensure the integrity of your data, you must finish data collection before you begin the transfer process. To end data collection, disconnect the modular cable from the interface.

For further information on the Data Shuttle option, refer to the Bedside/Transport Monitors chapter in the Ultraview Care Network Operations Manual (P/N 070-1150-XX, located on CD-ROM 084-1101-xx)

## Help Messages

If you are in doubt about a key, touch the monitor HELP key, and then touch the key in question. The monitor will display a brief description of its function.

# SenTec Digital Monitor

## Directory of Keys

(with PCO<sub>2</sub>/SpO<sub>2</sub>/PR parameters enabled on SenTec device)

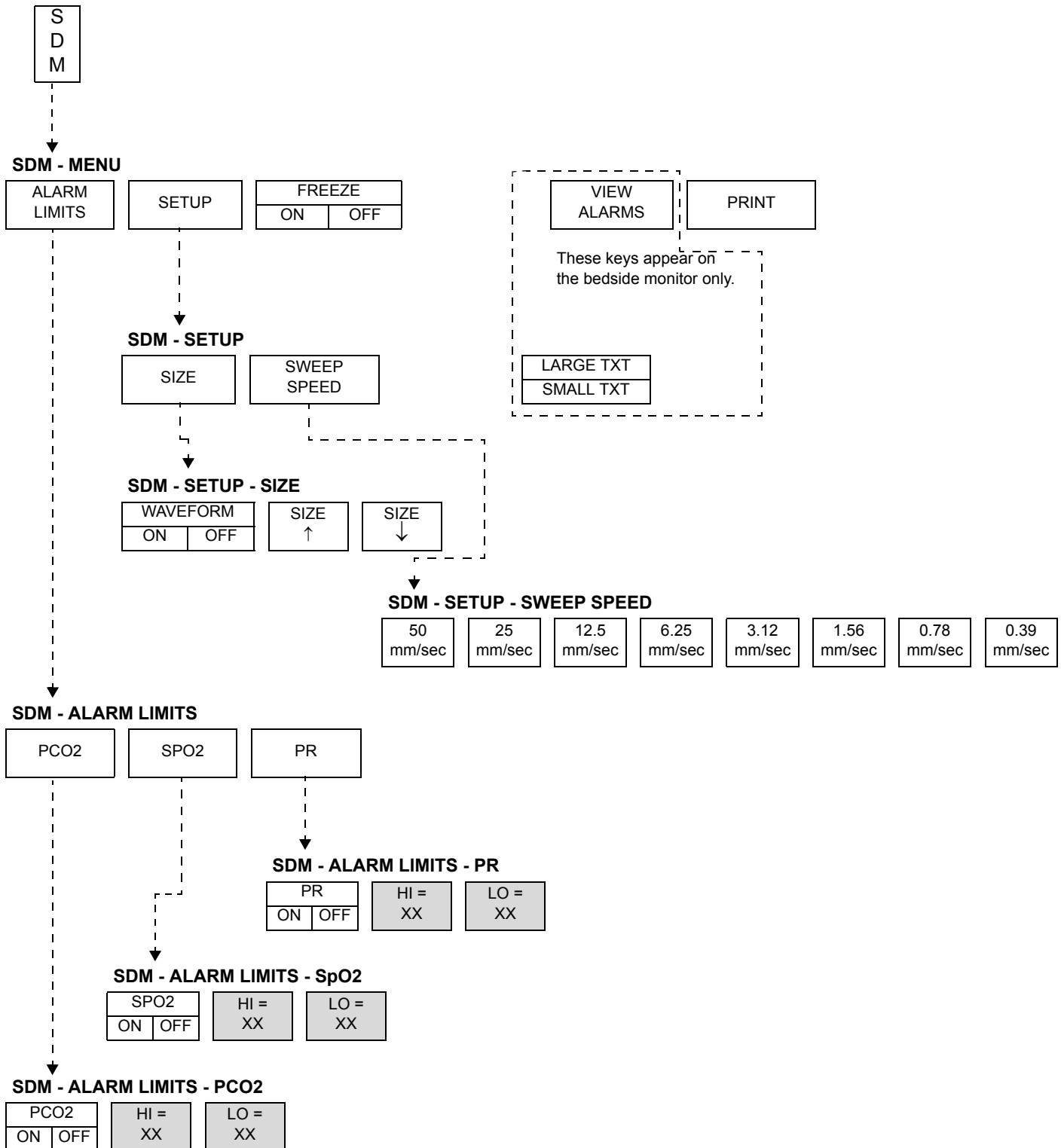

# Directory of Keys

(with only PCO<sub>2</sub> parameter enabled on SenTec device)

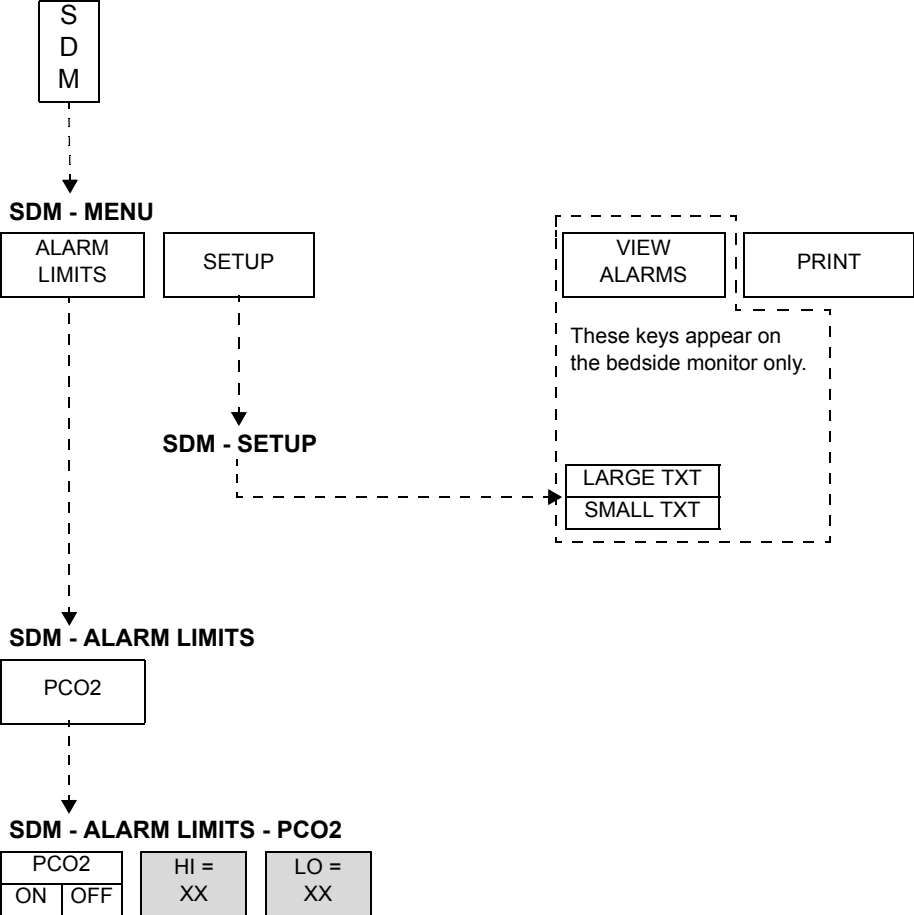

---

# SenTec Digital Monitor

---

---

## Contents

Overview . . . . .	3
Connecting the Flexport System Interface . . . . .	4
Display Detail . . . . .	4
Enabling Alarms . . . . .	6
Viewing Alarm Settings . . . . .	7
Entering Setup Information . . . . .	8
Freezing the Waveform on the Display . . . . .	10
Printing the Current Display . . . . .	10
Status Messages . . . . .	10

---

---

## Overview

The 90442A-03 Flexport system interface enables information from a SenTec Digital Monitor (SDM) to be displayed on Spacelabs Medical monitors.

Configure the SDM as shown in *Table 1*. Consult the SDM manual for additional configuration setup procedures.

*Table 1: SenTec Digital Monitor Configuration*

<b>Baud Rate</b>	<b>Minimum Software Revision</b>	<b>Installation Kit Part Number</b>	<b>Transition Connector Part Number</b>
9600	v06.10	045-0162-xx	131-1972-xx (9 pin)

## Connecting the Flexport System Interface

To connect the Flexport system interface to the SDM, complete the steps listed in the following Quickstart.

**To connect the Flexport system interface:**

- Connect the SDLC cable to the 9-pin male connector on the Flexport system interface as shown in *Figure 1-3* on page 1-3.
- Plug one end of the modular cable into the modular jack on the Flexport system interface.
- Plug the other end of the modular cable into the transition connector.
- Plug the transition connector into the 9-pin connector on the back of the SDM serial port.

The Spacelabs Medical monitor is now ready to display information from the SDM. To control other interface functions, refer to the sections that follow.

**Note:**

*During the warm-up phase, the PCO<sub>2</sub> values display in grey on the device and the monitor displays question marks (???). Once the device is sufficiently warmed up, PCO<sub>2</sub> values will display normally.*

---

## Display Detail

When you power ON a Spacelabs Medical monitor that is properly connected to a Flexport system interface, the monitor provides the following information from the SDM.

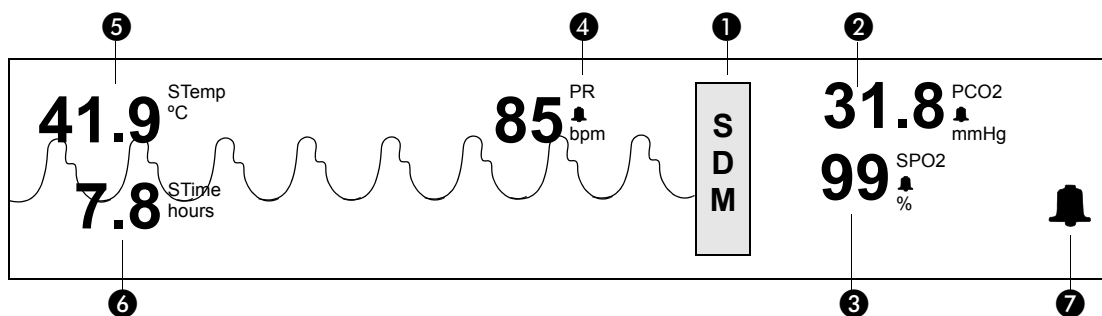

*Figure 2-1: Bedside monitor, large text screen with PCO<sub>2</sub>/SpO<sub>2</sub>/PR enabled*

# SenTec Digital Monitor

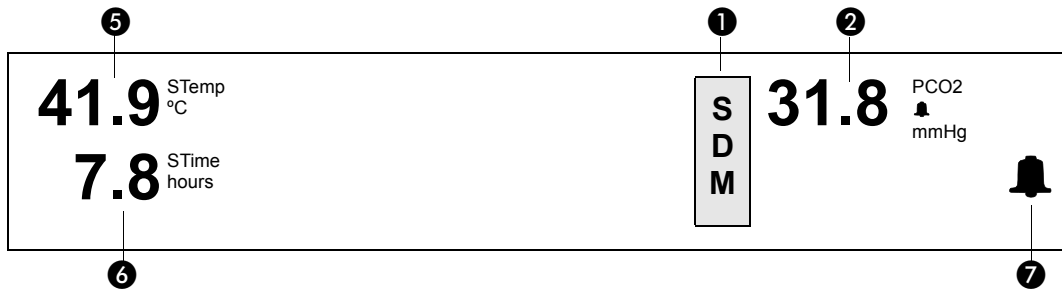

Figure 2-2: Bedside monitor, large text screen with only PCO<sub>2</sub> enabled

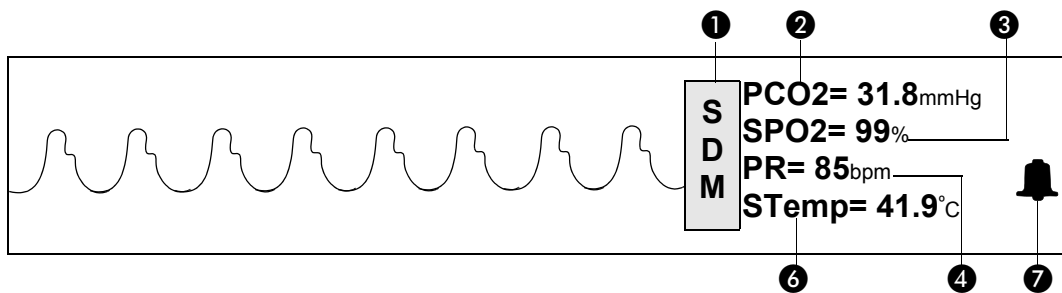

Figure 2-3: Bedside monitor, small text screen with PCO<sub>2</sub>/SpO<sub>2</sub>/PR enabled

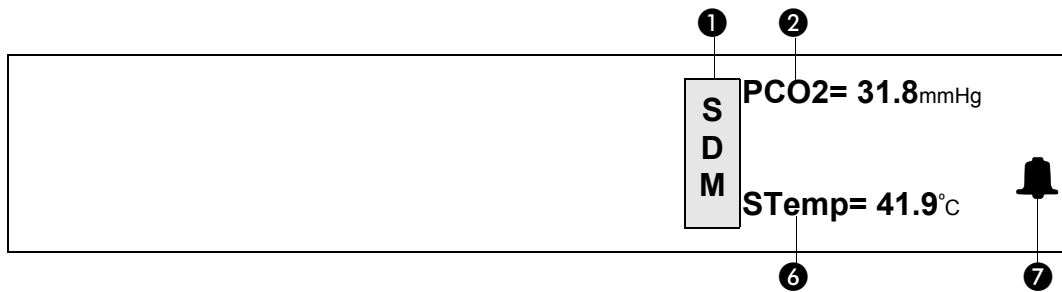

Figure 2-4: Bedside monitor, small text screen with only PCO<sub>2</sub> enabled

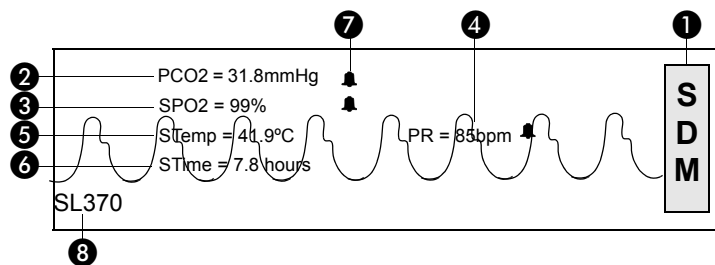

Figure 2-5: Central monitor, split screen with PCO<sub>2</sub>/SpO<sub>2</sub>/PR enabled

---

## SenTec Digital Monitor

---

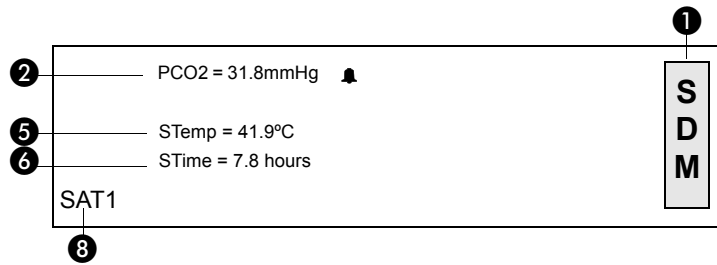

Figure 2-6: Central monitor, split screen with only PCO<sub>2</sub> enabled

- 1 SDM parameter key
- 2 Current PCO<sub>2</sub> (transcutaneous carbon dioxide tension) value
- 3 Current SpO<sub>2</sub> (oxygen saturation) value
- 4 Current PR (pulse rate) value
- 5 Current STemp (sensor temperature measured in °C) value
- 6 Current STime (site timer countdown clock) value
- 7 Alarm status bell (appears when alarms are turned ON)
- 8 Patient/room ID

---

## Enabling Alarms

The **Alarm Limits** menu allows you to enable alarm limits for each parameter. When an alarm is turned ON and that parameter value exceeds an alarm limit, all of the following occur:

- an alarm tone sounds,
- the SDM key flashes,
- the alarm limits key for that parameter flashes, and
- the alarm bell flashes.

When all parameter alarms are turned OFF, alarm status messages will still cause the SDM key to flash.

Alarm settings default to ON.

**Note:**

- *Turning Flexport system interface alarms ON or OFF does not affect alarm settings on the SDM.*
- *Alarm limits can only be adjusted at the SDM. Alarm violation is detected at the SDM, and the Flexport system interface reports the alarm if it is turned ON for that parameter.*
- *Alarm tones on the SDM can be selectively enabled or disabled. If alarm tones are also disabled at the Spacelabs Medical monitor(s), alarm violations will be reported visually only.*

**To turn alarms ON or OFF from the Spacelabs Medical monitor:**

- Touch SDM.
- Select ALARM LIMITS.
- Select an alarm parameter.
- Touch the parameter alarm ON/OFF key.

---

---

## Viewing Alarm Settings

The VIEW ALARMS key enables you to display the current alarm settings for the SDM's parameters (refer to *Figure 2-7*, *Figure 2-8*, *Figure 2-9*, and *Figure 2-10*). If alarms for all parameters are turned OFF, the Spacelabs Medical monitor displays SDM ALM OFF to the right of the SDM key. If alarms are turned ON for any parameter, a bell is displayed. The alarm bell flashes when an alarm limit is violated.

**To view alarm settings:**

- Touch SDM.
- Touch VIEW ALARMS.

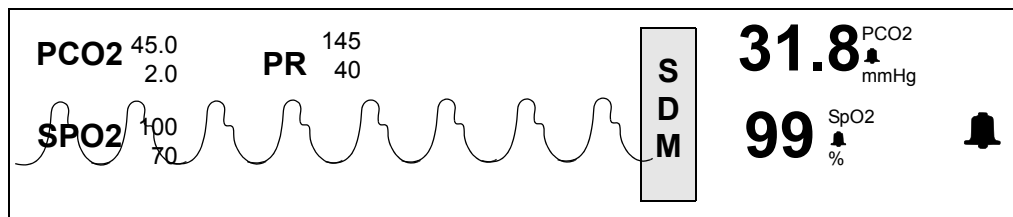

Figure 2-7: View Alarms screen, large text, PCO<sub>2</sub>/SpO<sub>2</sub>/PR enabled

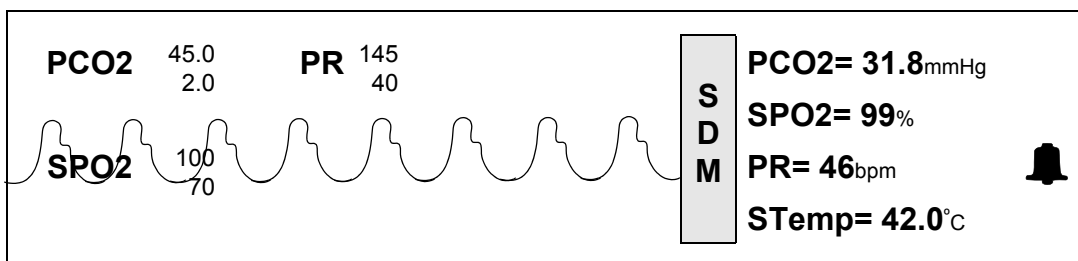

Figure 2-8: View Alarms screen, small text, PCO<sub>2</sub>/SpO<sub>2</sub>/PR enabled

---

## SenTec Digital Monitor

---

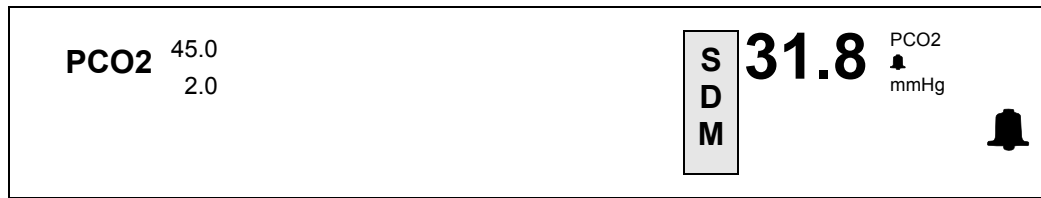

Figure 2-9: View Alarms screen, large text, only PCO<sub>2</sub> enabled



Figure 2-10: View Alarms screen, small text, only PCO<sub>2</sub> enabled

---

## Entering Setup Information

Changing setup information is helpful in optimizing the monitor display. The SETUP key controls the functions described below and affects only the monitor at which these adjustments are made.

### Turning Waveforms ON or OFF

You can turn waveforms OFF and display only the numeric values. When waveforms are OFF, the SIZE ↑ and SIZE ↓ keys, the SWEEP SPEED key, and the FREEZE ON/OFF keys are disabled.

The default setting is WAVEFORM ON.

When PCO<sub>2</sub> is the only parameter enabled on the SDM device, the WAVEFORM ON/OFF key, the SWEEP SPEED key, and the FREEZE ON/OFF keys are not displayed on Spacelabs Medical monitors.

#### To turn the waveform display ON or OFF:

- Touch SDM.
- Touch SETUP.
- Touch SIZE.
- Select WAVEFORM ON/OFF.

## Adjusting the Waveform Size

If the waveform is too large to fit within the display zone, use the waveform size keys to adjust the display size.

**Note:**

*The WAVEFORM ON/OFF key must be set to ON for the size keys to appear and function.*

**To adjust waveform size:**

- Touch SDM.
- Touch SETUP.
- Touch SIZE.
- Touch SIZE ↑ or SIZE ↓ to adjust the waveform size.

## Selecting a Sweep Speed

The sweep speed determines the speed at which the waveform trace moves across the display. Available sweep speeds are: 50, 25, 12.5, 6.25, 3.12, 1.56, 0.78, and 0.39 mm/second.

The default setting is 12.5 mm/second.

**To select a sweep speed:**

- Touch SDM.
- Touch SETUP.
- Touch SWEEP SPEED.
- Select the desired speed.

## Selecting a Display Format

Two display formats are available for the bedside monitor (refer to *Display Detail* on page 2-4).

The default setting is LARGE TXT.

**To select a display format:**

- Touch SDM.
- Touch SETUP.
- Select LARGE TXT or SMALL TXT.

## Freezing the Waveform on the Display

The FREEZE ON key enables you to freeze the waveform on the display. When you freeze the waveform, the Flexport system interface continues to process, update, and display numeric information.

The default setting is FREEZE OFF.

**To freeze the waveform on the display:**

- Touch SDM.
- Select FREEZE ON.

---

## Printing the Current Display

Touch the PRINT key to print the information shown on the current display. Each recording is identified by the bed name, patient name, time, and date.

**Note:**

- *The patient name you enter in the Spacelabs Medical monitor is the name that appears on the printout.*
- *The PRINT key does not print the waveform. A waveform recording is obtained by touching the monitor RECORD key.*

**To print the SDM display:**

- Touch SDM.
- Touch PRINT.

---

## Status Messages

The message COMMUNICATION LINK LOST indicates a problem with the SDM or cabling. If the monitor displays this message, perform the following troubleshooting steps:

- Verify that the SDM is powered ON.
- Verify that all cables are secure.

**Note:**

- *When powering OFF the SDM with all cables attached, do NOT power the SDM back ON until after the Flexport channel has disappeared from the Spacelabs Medical monitor (approximately one minute).*

## SenTec Digital Monitor

Table 2 lists the status messages that the Flexport system interface reports for the SenTec Digital Monitor during Flexport system interface operation.

*Table 2: Status Messages*

<b>Message Text</b>	<b>Indication</b>	<b>Alarm Sounds</b>
<i>MONITOR FAULT</i>	Monitor faulty, do not use — contact qualified service personnel.	Yes
<i>CONNECT SENSOR</i>	Sensor is not detected — if sensor is connected, replace, do not use.	Yes
<i>SENSOR FAULT</i>	The system detected a severe sensor fault. Sensor is shut down — do not use, replace sensor.	Yes
<i>TEMP. LIMITER ACTIVE</i>	Temperature surveillance detected a temperature problem.	Yes
<i>GAS LEAK IN DOCKING STATION</i>	Docking station (DS) surveillance detected a leak in the DS chamber (for example, polluted by sensor gel).	Yes
<i>SENSOR OFF PATIENT</i>	The sensor was dropped or is removed from the patient and calibration is needed.	Yes
<i>CALIBRATE SENSOR</i>	Sensor is removed from the docking station and calibration is needed.	Yes
<i>DOCKING STATION FAULT</i>	Docking station surveillance detected a severe DS fault (for example, the gas pressure too high).	Yes
<i>GAS BOTTLE EMPTY</i>	Gas bottle on the docking station is empty.	Yes
<i>SPO2 STABILIZING</i>	SpO <sub>2</sub> and pulse rate are not stable.	No
<i>LOW SIGNAL</i>	Low pulse signal.	No
<i>MOTION ARTIFACT</i>	Motion artifact detected.	No
<i>SITE TIME ELAPSED</i>	Check measurement site, and if necessary, relocate the sensor to prevent skin irritation.	Yes
<i>REMEMBRANCE SENSOR</i>	The sensor needs to be remembrance.	Yes
<i>BATTERY LOW</i>	Battery capacity is low (<10%) while the power supply cable is unplugged or the power supply is plugged in and charging.	Yes
<i>PCO2 STABILIZING</i>	PCO <sub>2</sub> measurement is not yet stable after sensor application. PCO <sub>2</sub> values do not yet reflect patient data.	No

---

## SenTec Digital Monitor











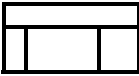











---

*Table 2: Status Messages (continued)*





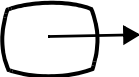











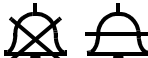

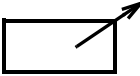
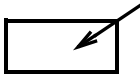





<b>Message Text</b>	<b>Indication</b>	<b>Alarm Sounds</b>
<i>READY FOR USE</i>	This sensor is removed from the docking station and calibration is NOT needed	No

# Appendix A — Symbols





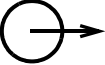















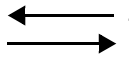
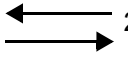

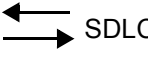



The following list of international and safety symbols describes all symbols used on Spacelabs Medical products. No one product contains every symbol.

	HELP Key		Keyboard Connection
	SPECIAL FUNCTIONS Key		Mouse Connection
	RECORD Key		START/STOP Key
	NORMAL SCREEN Key		START/STOP
	MONITOR SETUP Key		STOP or CANCEL Key
	ALARMS Key		CONTINUE Key
	PREVIOUS MENU Key		ENTER Key
	ON — Power Connection to Mains		OFF — Power Disconnection from Mains
	ON Position for Push Button Power Switch		OFF Position for Push Button Power Switch
	On Direction		ON/OFF
	Television; Video Display		Video Output
	ON — Part of the Instrument Only		OFF — Part of the Instrument Only











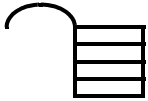
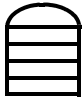





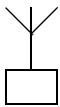

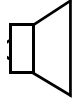

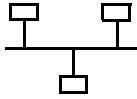
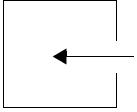
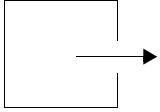
## Appendix A — Symbols

	Standby		STANDBY Key Power ON/OFF Key
	PAUSE or INTERRUPT		Slow Run
	Alarm Reset		Power Indicator LED
	Alarm Audio ON		Alarm Audio OFF
	Alarm Audio Paused		Activate Telemetry Recorder
	Indicator — Remote Control		Indicator — Local Control
	PRINT REPORT Key		Indicator — Out of Paper
	Partial ON/OFF		Recorder Paper
	Normal Screen		Return to Prior Menu
	Clock/Time Setting Key		TREND/TIMER Key
	HELP (Explain Prior Screen) Key		Keypad
	Activate Recorder for Graphics		Indoor Use Only
	START (NIBP) Key		Auto Mode (NIBP)
	Output (Non-terminated)		No Output (Terminated)

## Appendix A — Symbols

	Data Input/Output		Input/Output
	Input		Reset
	Menu Keys		Waveform/Parameter Keys
	Monitor Setup Select Program Options		Set Initial Conditions Menu
	Access Special Function Menu		Return Unit to Monitor Mode
	Serial Port 1		Serial Port 2
	External Marker Push Button Connection		SDLC Port
	Arterial Pulse		Electrocardiograph or Defibrillator Synchronization
	Gas Exhaust		Foot Switch
	Enlarge, Zoom		Delete
	PCMCIA Card		Event
	Keep Dry		Fragile; Handle with Care
	Environmental Shipping/Storage Altitude Limitations		This Way Up
	Environmental Shipping/Storage Temperature Limitations		Environmental Shipping/Storage Humidity Limitations

## Appendix A — Symbols

	Open Padlock		Closed Padlock
	Down Arrow		Up Arrow
	Hard Drive		Power Indicator LED
	Antenna		Mermaid Connector
	Microphone		Omnidirectional Microphone
	Audio Output, Speaker		Universal Serial Bus
	Network Connection	<b>Ref.</b>	Oxygen reference gas port
	Gas Sampling Port		Gas Return Port
	Low Priority Alarm		Nurse Call
	High Priority Alarm		Medium Priority Alarm
	Alarms Paused		Nurse Alert Interface
	Battery Status		Alarm OFF
	Battery Replace only with the appropriate battery.		Low Battery

## Appendix A — Symbols

	<p>All batteries should be disposed of properly to protect the environment. Lithium batteries should be fully discharged before disposal. Batteries such as lead-acid (Pb) and nickel-cadmium (Ni-Cd) must be recycled. Please follow your internal procedures and or local (provincial) laws regarding disposal or recycling.</p>		<p>Replace only with the appropriate battery. (+ / - signs may be reversed)</p>
	<p>Caution - hazardous voltages. To reduce risk of electric shock, do not remove the cover or back. Refer servicing to a qualified field service engineer (U.S.A.). DANGER - High Voltage (International)</p>		<p>This symbol indicates that the waste of electrical and electronic equipment <i>must not</i> be disposed as unsorted municipal waste and must be collected separately. Please contact an authorized representative of the manufacturer for information concerning the decommissioning of your equipment.</p>
	Protective Earth Ground		Functional Earth Ground
	Replace Fuse Only as Marked		Fuse
	<p>Power supply jack polarity. (+ / - signs may be reversed)</p>		Equipotentiality Terminal
	Alternating Current		Direct Current
	Both Direct and Alternating Current		AC/DC Input
A	Amperes	Hz	Hertz
V	Volts	W	Watts
	<p>IEC 60601-1 Type B equipment. The unit displaying this symbol contains an adequate degree of protection against electric shock.</p>		<p>IEC 60601-1 Class II equipment, double-isolated. The unit displaying this symbol does not require a grounded outlet.</p>

## Appendix A — Symbols

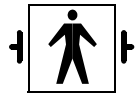

IEC 60601-1 Type BF equipment which is defibrillator-proof. The unit displaying this symbol is an F-type isolated (floating) patient-applied part which contains an adequate degree of protection against electric shock, and is defibrillator-proof.



IEC 60601-1 Type BF equipment. The unit displaying this symbol is an F-type isolated (floating) patient-applied part providing an adequate degree of protection against electric shock.



IEC 60601-1 Type CF equipment. The unit displaying this symbol is an F-type isolated (floating) patient-applied part providing a high degree of protection against electric shock, and is defibrillator-proof.



IEC 60601-1 Type CF equipment. The unit displaying this symbol is an F-type isolated (floating) patient-applied part providing a high degree of protection against electric shock.



Loop Filter



Adult NIBP



ETL Laboratory Approved



Canadian Standards Association Approved



Risk of Explosion if Used in the Presence of Flammable Anesthetics



Operates on Non-Harmonized Radio Frequencies in Europe

**Note**

Note



Attention - Consult Operations or Service Manual for Description

**Warning**

Warning About Potential Danger to Human Beings

**Caution**

Caution About Potential Danger to a Device



Noninvasive Blood Pressure (NIBP), Neonate



Fetal Monitor Connection (Analog)

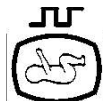

Fetal Monitor Connection RS-232 (Digital)



Physiological Monitor Connection RS-232 (Digital)



Happy Face



Sad Face

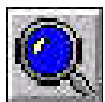

Magnifying Glass

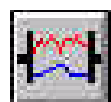

Compression

















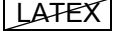





File Cabinet



List of Rooms

## Appendix A — Symbols

	Arrows		Printer
	Recycle		Service Message
	Non Sterile		PVC-Free
	Latex-Free		Do Not Reuse; Single Use Only
	Radio transmitting device; elevated levels of non-ionizing radiation		Reusable
	Batch Code		Catalog Number
	Date of Manufacture		Nellcor Oxisensor II Compatible
	UL recognized component in Canada and United States		Novamatrix Compatible
	Nellcor OxiMax Compatible		Spacelabs TruLink Compatible
	Masimo SET Compatible		Nellcor OxiMax Compatible
	Spacelabs Compatible		

**Abbreviations used as symbols are shown below.**

<b>1 - 32</b>	Access Codes 1 Through 32	<b>AIR</b>	Air
<b>ANT 1</b>	Diversity Antenna System 1	<b>Arr1</b>	Arrhythmia Net 1
<b>ANT 2</b>	Diversity Antenna System 2	<b>ArrNet2</b>	Arrhythmia Net 2

---

## Appendix A — Symbols

---

<b>CH</b> <b>ch</b>	EEG, EMG, or ECG Channel EEG Channels - CH1, CH2, CH3, CH4 EMG Channel - CH5	<b>cmH<sub>2</sub>O</b>	Centimeters of Water
<b>C.O.</b> <b>CO</b> <b>co</b>	Cardiac Output	<b>DIA</b> <b>dia</b>	Diastolic
<b>ECG</b> <b>ecg</b>	Electrocardiogram	<b>EEG</b> <b>eeg</b>	Electroencephalogram
<b>EMG</b> <b>emg</b>	Electromyogram	<b>ESIS</b>	Electrosurgical Interference Suppression
<b>EXT</b>	External	<b>FECG</b>	Fetal Electrocardiogram
<b>FHR1</b> <b>FHR2</b>	Fetal Heart Rate, Channel 1 Fetal Heart Rate, Channel 2	<b>GND</b> <b>gnd</b>	Ground
<b>HLO</b> <b>hlo</b>	High-Level Output	<b>Multiview</b>	Multi-Lead Electrocardiogram
<b>NIBP</b> <b>nibp</b>	Noninvasive Blood Pressure	<b>N<sub>2</sub>O</b>	Nitrous Oxide
<b>O<sub>2</sub></b>	Oxygen	<b>PRESS</b> <b>press</b> <b>PRS</b>	Pressure
<b>RESP</b> <b>resp</b>	Respiration	<b>SDLC</b>	Synchronous Data Link Control
<b>SPO<sub>2</sub></b> <b>SpO<sub>2</sub></b> <b>SpO<sub>2</sub></b> <b>SaO<sub>2</sub></b>	Arterial Oxygen Saturation as Measured by Pulse Oximetry	<b>SVO<sub>2</sub></b> <b>SvO<sub>2</sub></b> <b>SvO<sub>2</sub></b>	Mixed Venous Oxygen Saturation
<b>SYS</b> <b>sys</b>	Systolic	<b>T1</b> <b>T2</b> <b>T3</b> <b>T4</b>	Temperature 1 Temperature 2 Temperature 3 Temperature 4
<b>TEMP</b> <b>temp</b>	Temperature	<b>UA</b>	Uterine Activity or Umbilical Artery

---

## Appendix A — Symbols

---

**VAC** Vacuum Connection

**UV** Umbilical Venous

